

REFER TO STRUCTURAL ENGINEERS DRAWINGS FOR DETAILS OF SUPPORTING STEELWORK.

STUD PARTITIONING K10/118.
 HYGENIC WALL PANELLING K13/120.
 COLD ROOM PANELS K30/127.

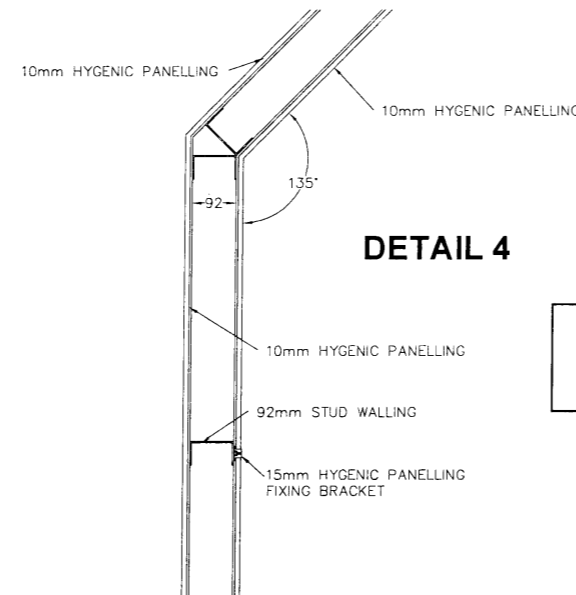

ALL BATTENS MUST BE ADHESIVE FIXED TO COLD ROOM PANELS. MDF FIXINGS MUST NOT PENETRATE COLD ROOM PANELS.

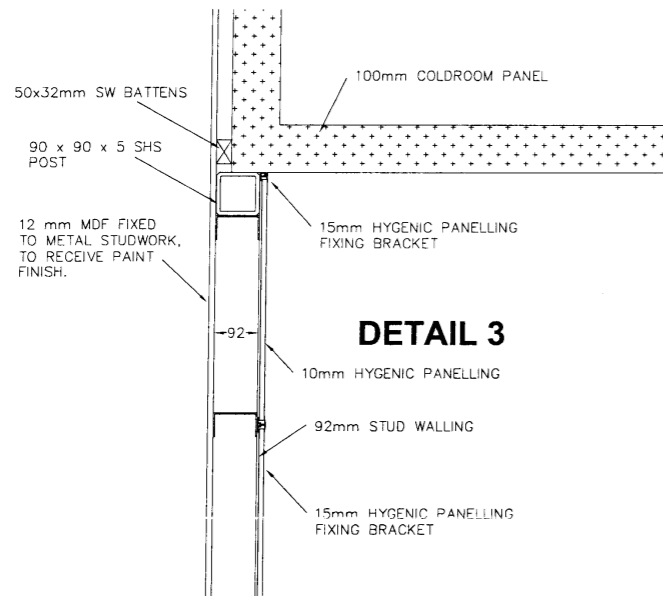
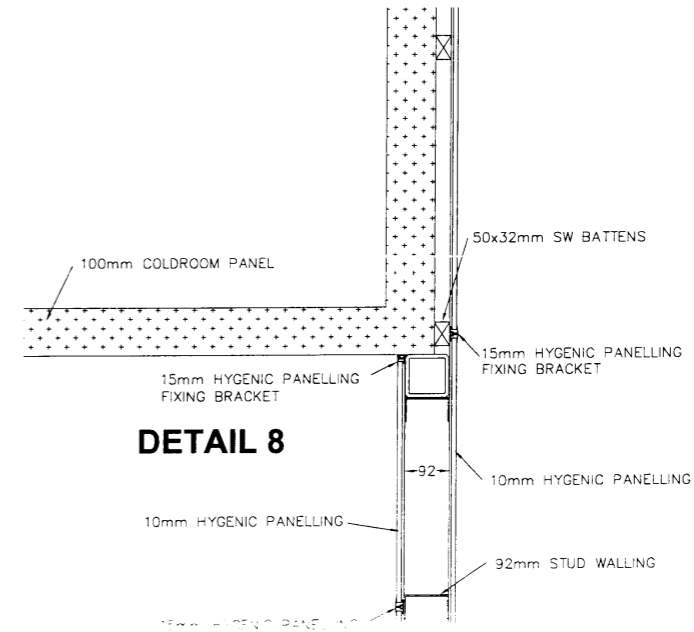
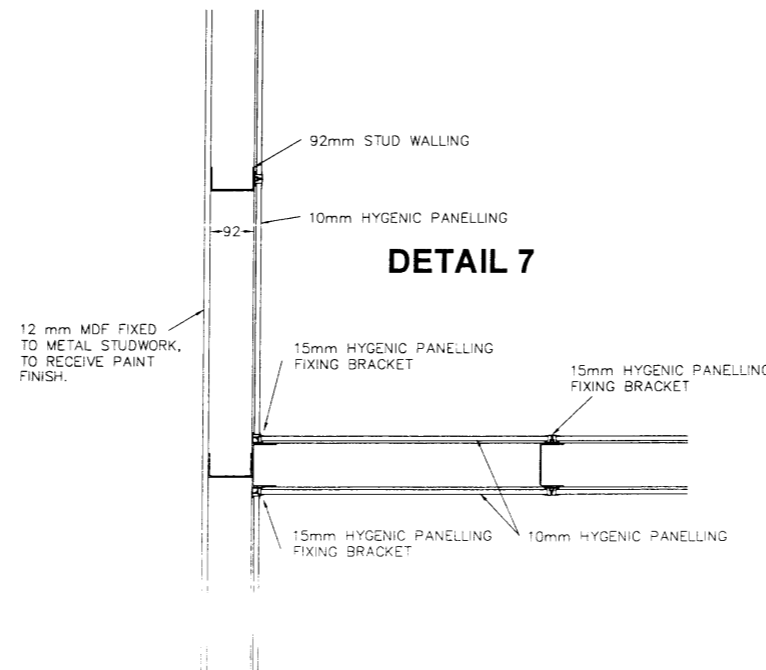
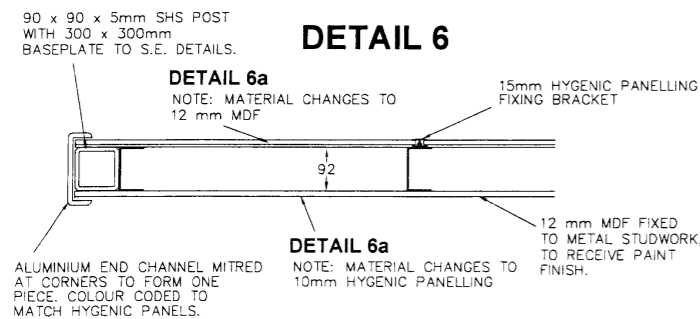
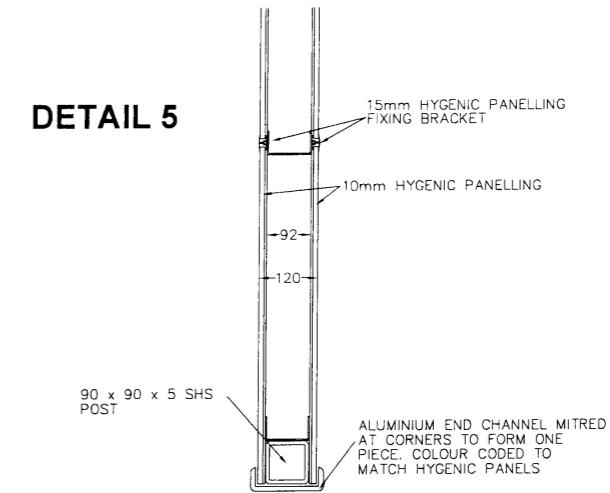

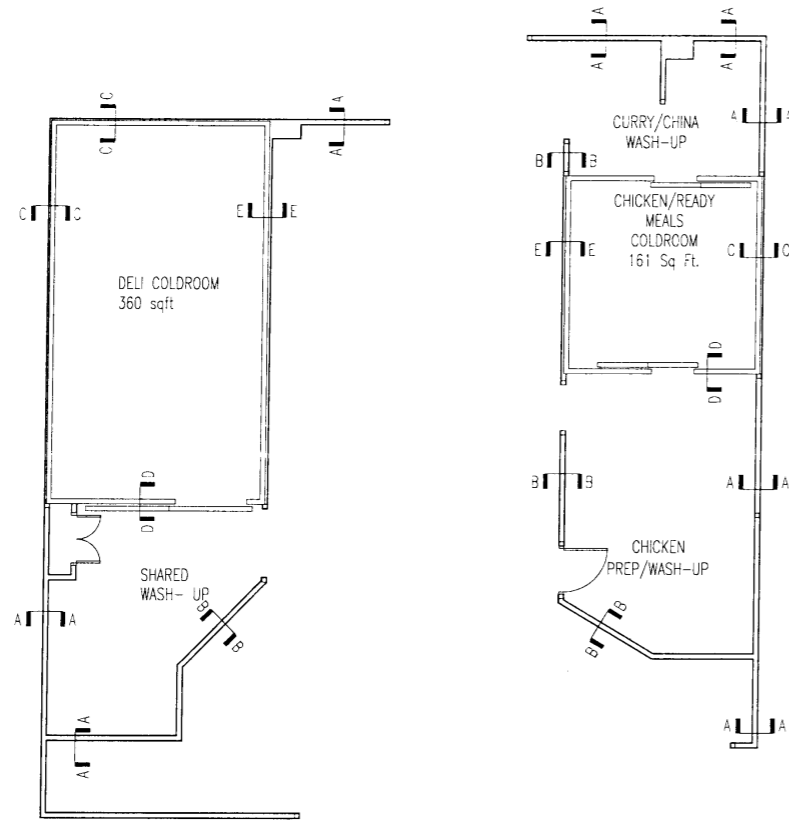

LOCATION PLAN (SCALE 1:50)

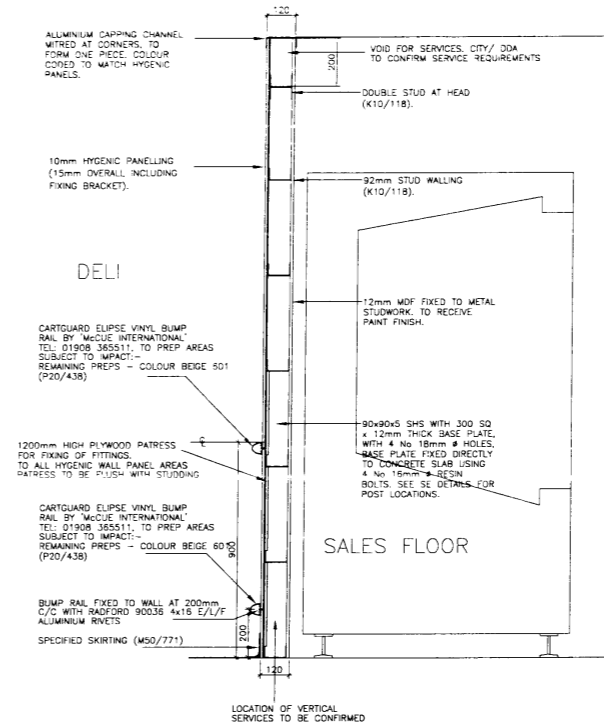

SECTION AA
Scale 1:10

ALL BATTENS MUST BE ADHESIVE FIXED TO COLD ROOM PANELS. MDF FIXINGS MUST NOT PENETRATE COLD ROOM PANELS.

REFER TO STRUCTURAL ENGINEERS DRAWINGS FOR DETAILS OF SUPPORTING STEELWORK.
STUD PARTITIONING K10/118.
HYGIENIC WALL PANELLING K13/120.
COLD ROOM PANELS K30/127.

NOTE:
ALL SERVICES TO BE CONCEALED.

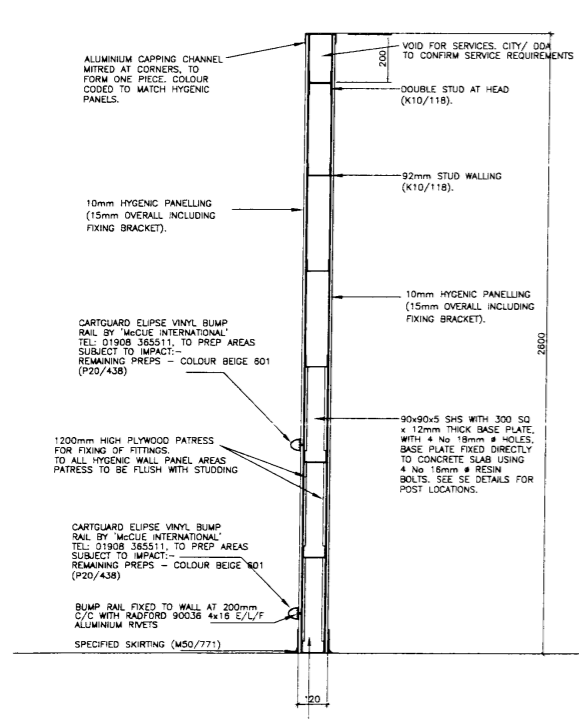

SECTION BB
Scale 1:10

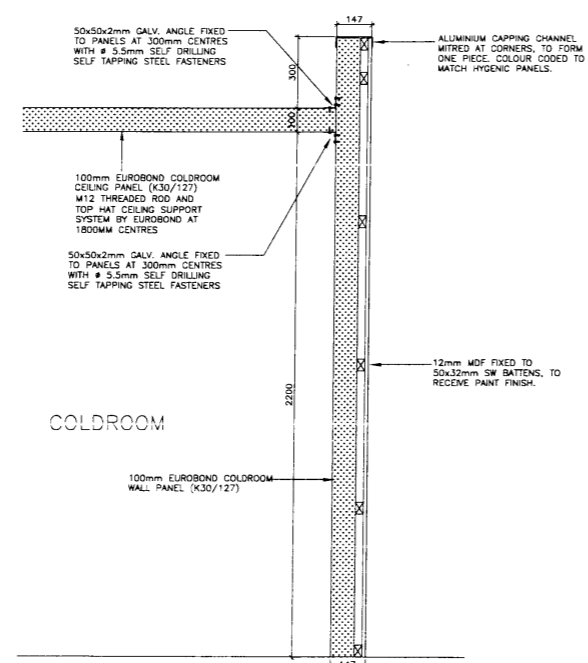

SECTION CC
Scale 1:10

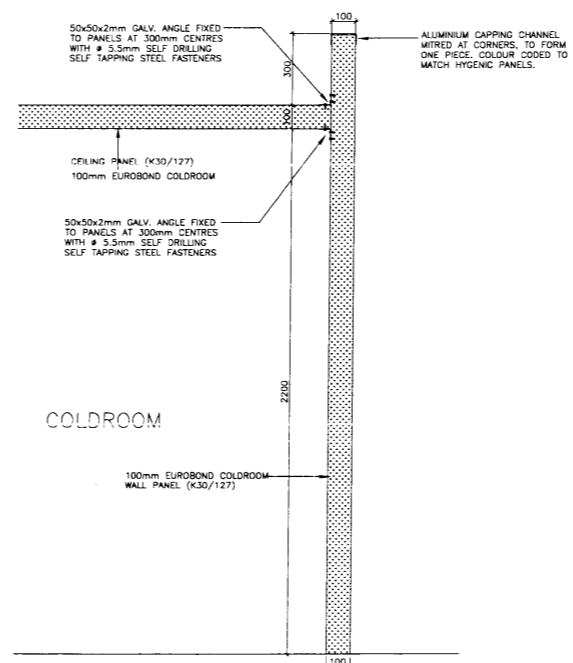

SECTION DD
Scale 1:10

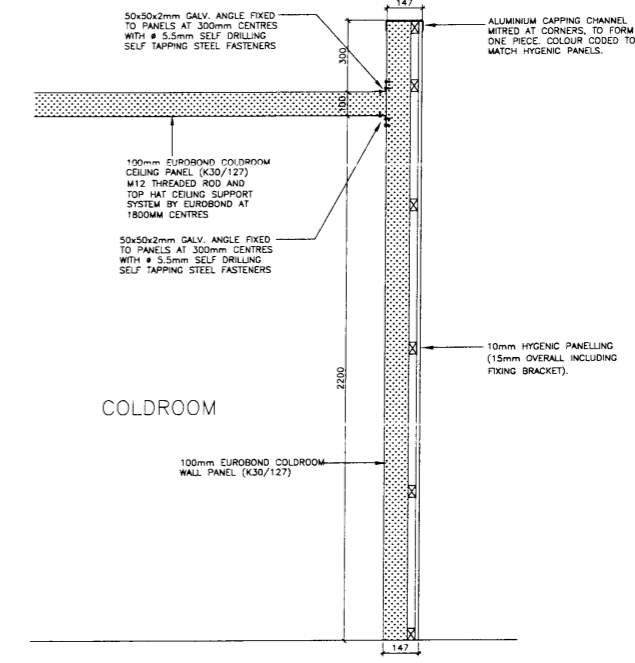

SECTION EE
Scale 1:10